

## Item # 28A2432-0A2 Broadband Split / Snap-on Ferrite Cores for Round Cables

### Broadband Split / Snap-on Ferrite Cores for Round Cables

For retrofit and post-assembly operations, Laird Technologies offers a selection of "split" components. Similar in performance to Laird Technologies' one piece core designs, these split ferrite cores provide excellent common and differential mode EMI suppression on round cable assemblies. Lightweight, inexpensive plastic snap-on cases provide secure closure of the split cores onto the cable.



[larger image](#)

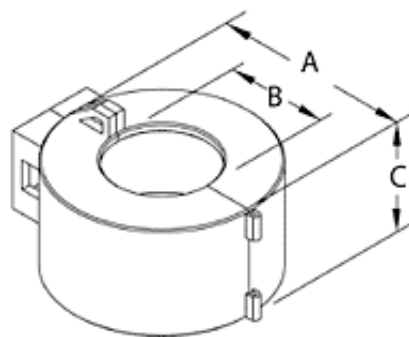

[larger image](#)

### Specifications

<b>Figure Number</b>	3
<b>Case A</b>	19.20 mm
<b>Case B</b>	8.20 mm
<b>Case C</b>	19.90 mm
<b>Case D</b>	23.10 mm
<b>Case E</b>	26.10 mm
<b>Max. Cable Diameter</b>	0.320 in 8.13 mm
<b>Typical Z Ohms at 25 MHz</b>	62
<b>Nominal Z Ohms at 100 MHz</b>	160
<b>Typical Z Ohms at 300 MHz</b>	300
<b>Material Type</b>	Broad Band Material
<b>Product Type Code</b>	Split round cores (Snap-Ons)
<b>Part Size Code</b>	2432
<b>Additional Description</b>	Plastic Case

**Case Color**

Black

[Print](#)

[Back](#)